

LA HR080EP1

LED Chip Hyper red (650 nm) 12 x 9 mil



A Brand of Chips 4 Light GmbH

Remarkable light extraction is reached by a particular top emitting design with vertical chip structure and homogeneous current distribution. Furthermore the LED die shows excellent reliability performance and can be operated with very high current densities.

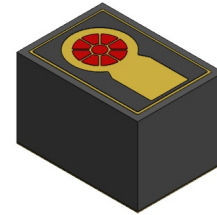

Features

- Fast response time
- p-side up chip
- Enhanced coupling efficiency
- Resonant cavity LED
- Emitting aperture: 80µm
- Datarate of 155 Mbps possible

Applications

- Sensors
- Industrial applications
- Architectural lighting
- Data communication

Delineation

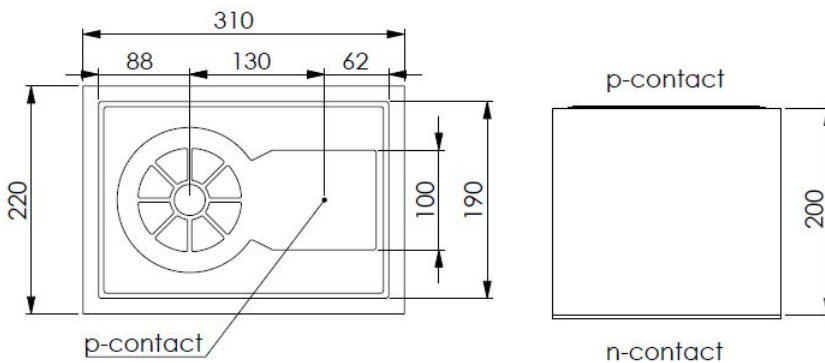

All dimensions in µm.

Mechanical characteristics

DESCRIPTION	MINIMUM	TYPICAL ¹	MAXIMUM
Chip size (µm)	290 x 170	310 x 190	330 x 210
Chip height (µm)	180	200	220
Bond pad diameter (µm)	80	100	120
Top contact	Anode (p), gold		
Bottom contact	Cathode (n), gold alloy		
Die attach	Epoxy bonding, Soldering		

LA HR080EP1

LED Chip Hyper red (650 nm) 12 x 9 mil

Electro-optical characteristics ($T_A = 25^\circ\text{C}$)²

PARAMETER	SYMBOL	CONDITION	MIN.	TYP. ¹	MAX.	UNIT
Forward voltage	V_F	$I_F = 20\text{ mA}$		2	2.2	V
Reverse current	I_R	$V_R = 5\text{ V}$			10	μA
Peak wavelength	λ_{peak}	$I_F = 20\text{ mA}$	640	650	660	nm
Spectral bandwidth	$\Delta\lambda$	50% $I_{e,\text{rel}}$		7		nm
Radiant power	Φ_e	$I_F = 20\text{ mA}$		1	1.5	mW
Beam divergence		$I_F = 20\text{ mA}$		90		°
Rise time and fall time	$t_R; t_F$	$I_F = 20\text{ mA}; (10\% - 90\%)$		3		ns

Maximum ratings ($T_A = 25^\circ\text{C}$)³

PARAMETER	SYMBOL	VALUE	UNIT
Operating temperature range	T_{op}	-20...70	°C
LED junction temperature	T_j	125	°C
Forward current	I_F	30	mA
Pulse current	I_P	100	mA
Temperature coefficient	P_0	-0.6	%/°C
Temperature coefficient	λ_P	0.07	nm/°C

Typical characteristics graphs

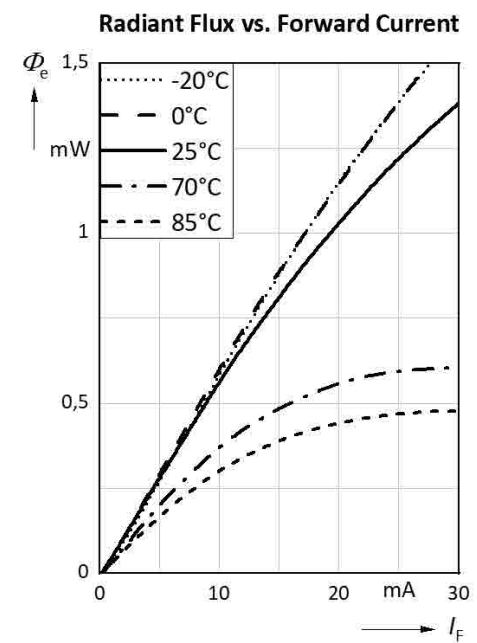
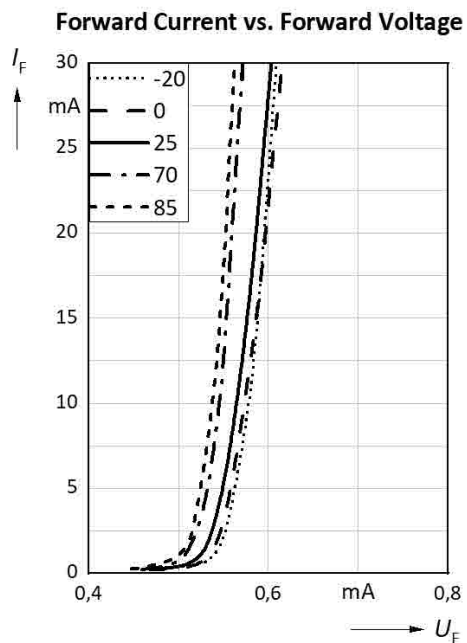
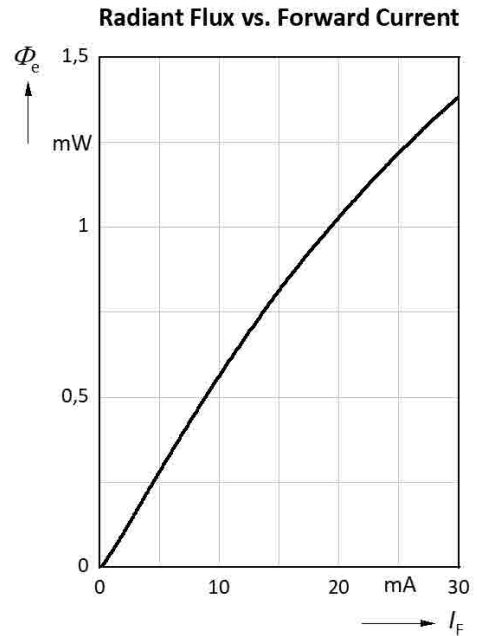
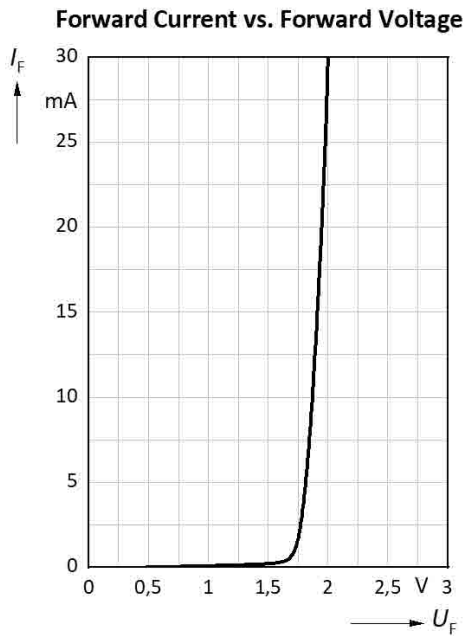

LA HR080EP1

LED Chip Hyper red (650 nm) 12 x 9 mil

Spectrum (Relative Intensity vs. Wavelength)

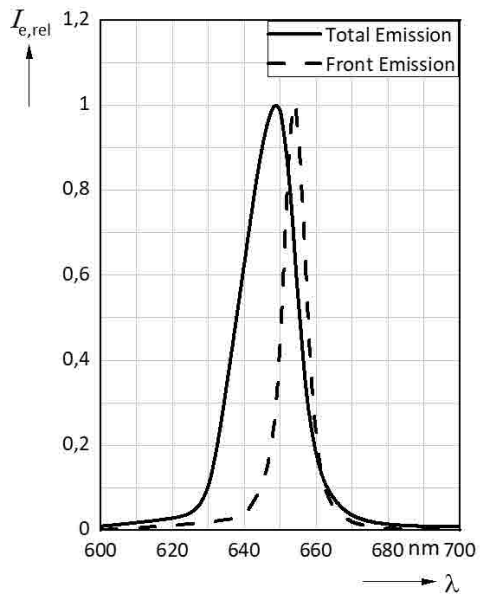

Radiation Pattern

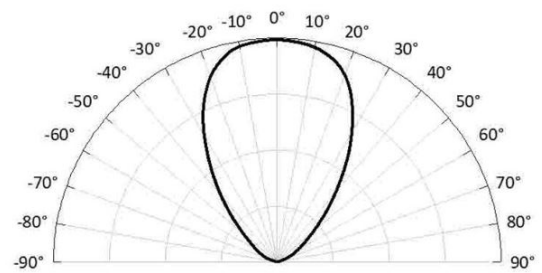

LA HR080EP1

LED Chip Hyper red (650 nm) 12 x 9 mil



A Brand of Chips 4 Light GmbH

Handling and storage conditions

Storage time for wafers in sealed condition is not limited by the die itself, but may be limited by the adhesion of the blue foil (storage ambient conditions: $T_a = 15 \dots 30^\circ\text{C}$; relative humidity: $< 60\%$, vertical storage). Therefore we ship the dice without any limitation of shelf life. Customer has to make sure that there is no glue from the adhesive foil on the backside either by a die shear test or by visual inspection of the backside before production. The hermetically sealed shipment lot shall be opened under temperature and moisture controlled cleanroom environment only. Customers have to follow the according rules for desposition as the material can be hazardous for humans and the environment. Chips are placed on a blue foil, which may contain the following substance in a concentration of circ.18% wt: Bis (2-ethyl(hexyl)phthalate) (DEHP) [CAS #: 117-81-7; EC # 204-211-0]. Dice have to be handled ESD sensitive.

Packing

Chips are placed on a blue foil inside a 6 inch ring or alternatively on a blue foil (mylar). For shipment the wafers of a shipment lot are arranged to stacks. Please use the recycling operators familiar to you. If required you can ask for our help. Please get in touch with your nearest sales office. By agreement we will take packing material back, if sorted. Transport costs of any kind must be paid by customers. For packing material that is returned to us unsorted or which we are not obliged to accept, any costs incurred will be invoiced to you.

Design objectives

The chip design was developed and released based on the producer's standard assembly procedures and packaging. Bond strength properties are in accordance to MIL-STD-750D, method 2037. Whether the chip fits to the customer's products with its according die and wire bond procedures and packaging must be evaluated by the customer himself. If workability problems arise after this release a mutually conducted problem solving procedure has to be set up, if the chips are suspected of contributing to the problems. The chips are produced with best effort, but on chip level a subset of the chip characteristics can be determined only. Performance of the chip in the customer's products can only be determined by the customer himself.

Returns and complaints

For complaints and returns of material a RMA-number is necessary. Samples for analysis purposes can be send to us without credit.

Shipping conditions

If not otherwise arranged, the "General Terms of Business of Chips 4 Light GmbH" apply for any shipment. If this document is not familiar to you, please request it at our nearest sales office.

LA HR080EP1

LED Chip Hyper red (650 nm) 12 x 9 mil



A Brand of Chips 4 Light GmbH

Disclaimer

Attention please!

- **Components used in life-support devices or systems must be expressly authorized for such purpose!**

Critical components⁴ may only be used in life-support devices⁵ or systems with the express written approval by us.

- All products, product specifications and data to improve reliability, function, design or otherwise are subject to change without notice .
- Chips 4 Light GmbH, its affiliates, agents, and employees, and all persons acting on its or their behalf, disclaim any and all liability for any errors, inaccuracies or incompleteness contained in any datasheet or in any other disclosure relating to any product. Chips 4 Light makes no warranty, representation or guarantee regarding the suitability of the products for any particular purpose or the continuing production of any product. To the maximum extent permitted by applicable law, Chips 4 Light disclaims (i) any and all liability arising out of the application or use of any product, (ii) any and all liability, including without limitation special, consequential or incidental damages, and (iii) any and all implied warranties, including warranties of fitness for particular purpose, non-infringement and merchantability. Statements regarding the suitability of products for certain types of applications are based on Chips 4 Light's knowledge of typical requirements that are often placed on Chips 4 Light's products in generic applications. Such statements are not binding statements about the suitability of products for a particular application. It is the customer's responsibility to validate that a particular product with the properties described in the product specification is suitable for use in a particular application. Parameters provided in datasheets and/or specifications may vary in different applications and performance may vary over time. All operating parameters, including typical parameters, must be validated for each customer application by the customer's technical experts. Product specifications do not expand or otherwise modify Chips 4 Light's terms and conditions of business, including but not limited to the warranty expressed therein. Except as expressly indicated in writing, Chips 4 Light's products are not designed for use in medical, life-saving, or life-sustaining applications or for any other application in which the failure of the Chips 4 Light product could result in personal injury or death. Customers using or selling Chips 4 Light products not expressly indicated for use in such applications do so at their own risk. Please contact authorized Chips 4 Light personnel to obtain written terms and conditions regarding products designed for such applications. No license, express or implied, by estoppel or otherwise, to any intellectual property rights is granted by this document or by any conduct of Chips 4 Light. Product names and markings noted herein may be trademarks of their respective owners.
- The information describes the type of component and shall not be considered as assured characteristics. Due to technical requirements components may contain dangerous substances. For information on the types in question please contact our Sales Organization.
- Lead free product - RoHS compliant.
- The quality level of the final visual inspection shall comply to an AQL of 1.0 (according to MIL-STD-105E, level II), if the customer performs an incoming visual inspection of a shipment.

LA HR080EP1

LED Chip Hyper red (650 nm) 12 x 9 mil

- All chips are checked according to the producer's specification of the visual inspection. If this document is not familiar to you, please request it at our nearest sales office.

Changes

VERSION	DATE	CONTENT
1.0	20.03.2025	First publication.

Published by:
Chips 4 Light GmbH
Am Kuehlen Kasten 8
93161 Sinzing
Germany
www.chips4light.com
info@chips4light.com
© All Rights Reserved

¹Due to the special conditions of the manufacturing processes of LED, the typical data or calculated correlations of technical parameters can only reflect statistical figures. These do not necessarily correspond to the actual parameters of each single product, which could differ from the typical data and calculated correlations or the typical characteristic line. If requested, e.g. because of technical improvements, these typ. data will be changed without any further notice.

²Measurements are done with an accuracy of $\pm 15\%$. Correlation to customer's equipment and products is required.

³Maximum ratings are package dependent and may differ between packages. The forward current is not limited by the die but by the effect of the LED junction temperature on the package. If you need more information on pulsed operation, please contact your next sales office about possible driving conditions. If not otherwise specified the maximum pulse current may not exceed the maximum current in continuous mode.

⁴A critical component is a component used in a life-support device or system whose failure can reasonably be expected to cause the failure of that life-support device or system, or to affect its safety or the effectiveness of that device or system.

⁵Life support devices or systems are intended(a) to be implanted in the human body, or(b) to support and/or maintain and sustain human life. If they fail, it is reasonable to assume that the health and the life of the user may be endangered.