

LA OM5090YLL

50 x 90° Yellow Oval LED (590 nm)



Light Avenus's 50°/90° Radial LED series is designed for high flux and high temperature applications. The usage of special materials allows junctions temperatures up to 140° C. A highly automated production process ensures high volume capability and competitive pricing.

Features

- Long lifetime
- High optical precision
- High optical efficiency
- High operating temperatures

Applications

- Industry
- Sensor
- Automotive
- Illumination
- Consumer

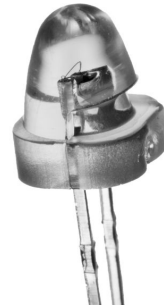

Dimensions

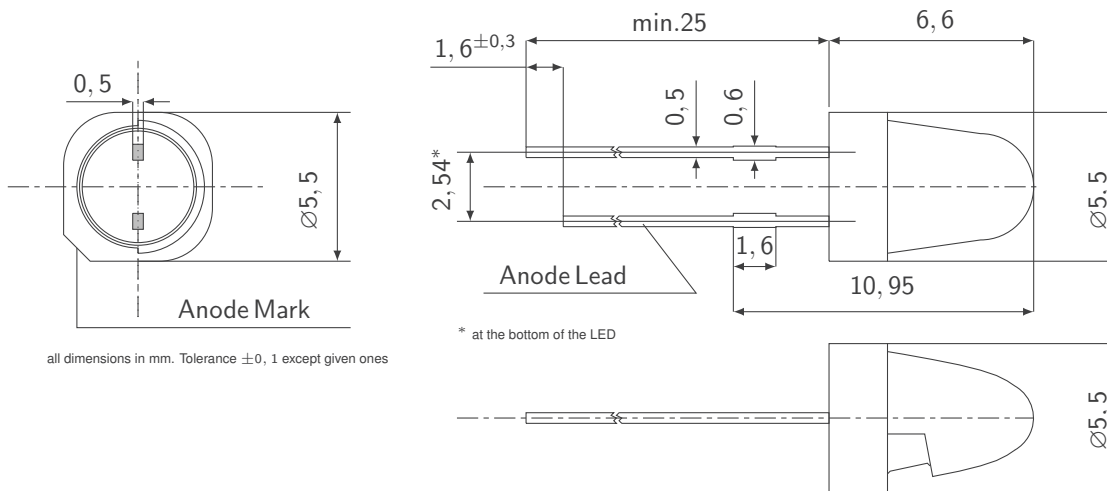

Ordering information

TYPE	DOMINANT WAVELENGTH	LUMINOUS FLUX
LA OM5090YLL-03AL08	585 ... 597 nm	2 ... 8 lm



- L A Light Avenue
- O Oval LED
- M Medium current
- 5 0 9 0 50 x 90° vertical and horizontal viewing angle
- Y L Yellow
- L AllnGaP high luminous flux chip
- 0 Dominant wavelength min.: 585 nm
- 3 Dominant wavelength max.: 597 nm
- A Luminous Flux min.: 2 lm
- L Luminous Flux max.: 8 lm
- 0 Voltage min.: 1,75 V
- 8 Voltage max.: 2,75 V

LA OM5090YLL

50 x 90° Yellow Oval LED (590 nm)



Electro-optical characteristics ($T_A = 25^\circ\text{C}$)²

PARAMETER	SYMBOL	CONDITION	MIN.	TYP. ¹	MAX.	UNIT
Luminous Flux	Φ_v	$I_f = 50\text{ mA}$	2	5	8	lm
Luminous intensity	I_v	$I_f = 50\text{ mA}$		2,5		cd
Forward voltage	V_F	$I_f = 50\text{ mA}$	1,75	2,20	2,75	V
Peak wavelength	λ_{peak}	$I_f = 50\text{ mA}$	585	590	597	nm
Spectral width	RMS	$I_f = 50\text{ mA}$		20		nm
Beam Divergence Angle	θ	$I_f = 50\text{ mA}$		50 x 90		°

Maximum ratings ($T_A = 25^\circ\text{C}$)

PARAMETER	SYMBOL	CONDITION	MINIMUM	MAXIMUM	UNIT
Operating Current	$I_{f,max}$			70	mA
Operating Pulse Current	$I_{fp,max}$	$t_p = 10\mu\text{s}, D = 2\%$		100	mA
Operating Temperature	T_{op}		-40	120	°C
Storage Temperature	T_{st}		-50	125	°C
Junction Temperature	T_j			140	°C
Reverse Voltage	V_R		10		V
Power Consumption	P_{tot}			180	mW

Binning ($I_F = 50\text{ mA}$)

DOMINANT WAVELENGTH (NM)			LUMINOUS FLUX (LM)			VOLTAGE (V)		
Bin	Min.	Max.	Bin	Min.	Max.	Bin	Min.	Max.
0	585	588	A	2	2,25	0	1,75	1,95
1	588	591	B	2,25	2,5	1	1,85	2,05
2	591	594	C	2,5	2,8	2	1,95	2,15
3	594	597	D	2,8	3,2	3	2,05	2,25
			E	3,2	3,6	4	2,15	2,35
			F	3,6	4	5	2,25	2,45
			G	4	4,5	6	2,35	2,55
			H	4,5	5	7	2,45	2,65
			I	5	5,6	8	2,55	2,75
			J	5,6	6,4			
			K	6,4	7,2			
			L	7,2	8			

Thermal characteristics

PARAMETER	SYMBOL	VALUE	UNIT
Thermal resistance junction ambient	$R\Theta_{JA}$	180	K/W
Soldering temperature (3 seconds maximum)	T_{sold}	260	°C

Recommended Solderpad

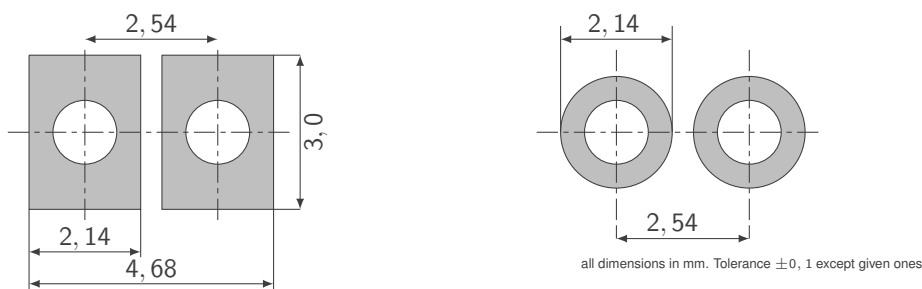

Soldering

METHOD	SOLDERING CONDITIONS	REMARK (VALID FOR TTW AND LEAD FREE SOLDERING)
TTW soldering	Bath temperature 250°C, Immersion time: within 5 sec.	Soldering system: Very good soldering results have been achieved on ERSA soldering systems at a bath temperature of 250°C and at a feeding rate of 1.2 m/s.
Lead free soldering	Bath temperature 260°C, immersion time: within 3 sec.	We recommend dosage of the soldering flux with a spray fluxer or nozzle fluxer. If this is not possible, one should pay attention to avoid contact of the soldering flux and the LED body and to keep the recommended preheat period. We recommend to use a water based soldering flux (e.g. Pacific 2007 interflux Electronics NV). Do not use alcohol based fluxer.
Soldering iron	30W or smaller, temperature at tip of iron maximum 300°C, soldering time within 3 sec.	During soldering take care not to press the tip of iron against the lead. To prevent heat from being transferred directly to the lead hold the lead with a pair of tweezers while soldering.

Actual solder profile may vary from the example given, and is very much depending on wave type, machine configuration, geometrical configuration, board shape etc. It is strongly recommended to optimize and

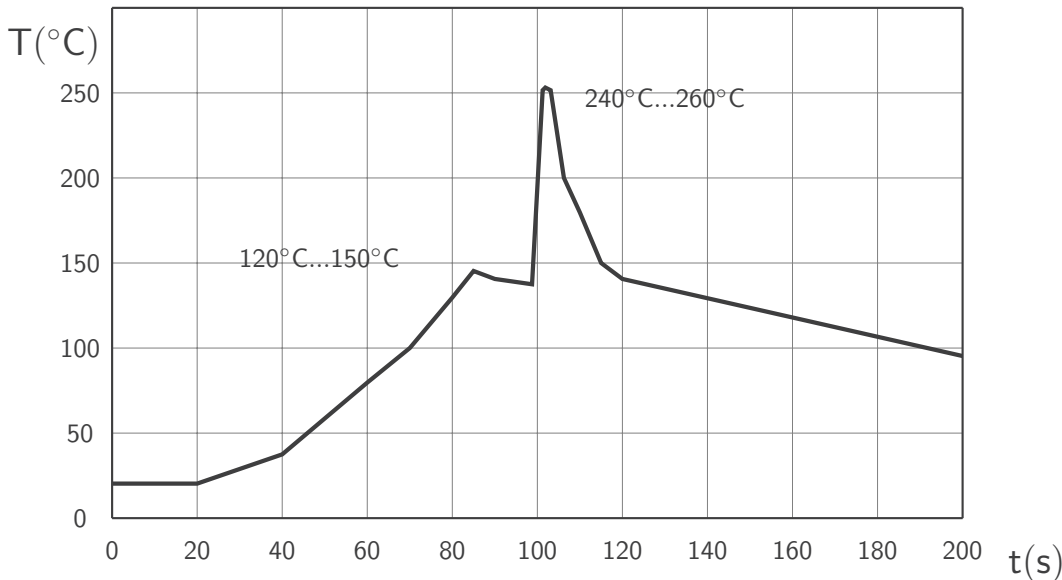

evaluate the actual soldering conditions carefully for each individual project before releasing the soldering process.

Mounting

- The lead should be bent at a point located at least 0.8 mm away from the package. Bending should be performed with base firmly fixed by means of a jig or radio pliers.
- Lead binding should be carried out prior to soldering and never during or after soldering.
- Locate the lead, ensuring correct alignment, thereby reducing stress to the LED.
- Due to thermoplastic encapsulant the LEDs are slightly more sensitive to the effects of stress during automatic mounting (such as mechanical stress within the package resin transmitted via the leads).
- The insertion pressure and clinching angle must both be minimized so as to minimize the lead-cutting stress and clinch stress applied to the LED lamps.
- Please evaluate the specific mounting process carefully for each individual project before actually using the automatic mounting machine to mount these LED lamps. Setting the best clinch angle and force may require experimentation when the automatic insertion machine is first set up.
- Please pay attention: The heat sink lead is also the anode lead at the same time. Metal pads on PCB surrounding the heat sink leads of the LEDs should be as large as possible.



Cleaning and Coating

Do not use untested chemical liquids, because they may cause crack formation or haze on the surface of the plastic body. When cleaning is required, refer to the following table for the proper chemical to be used (Immersion time less than 3 minutes at room temperature).

SOLVENT	ADABTABILITY
Water	can be used
Amonium Hydroxide	can be used

Should you intend to provide the LEDs with a conformal coating, please take care to use a water-based coating.

Typical electro-optical data²

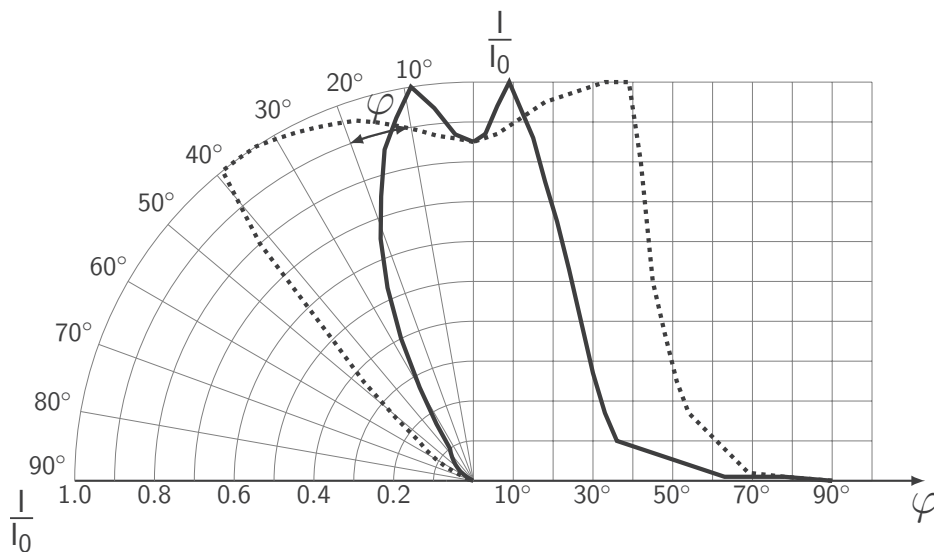
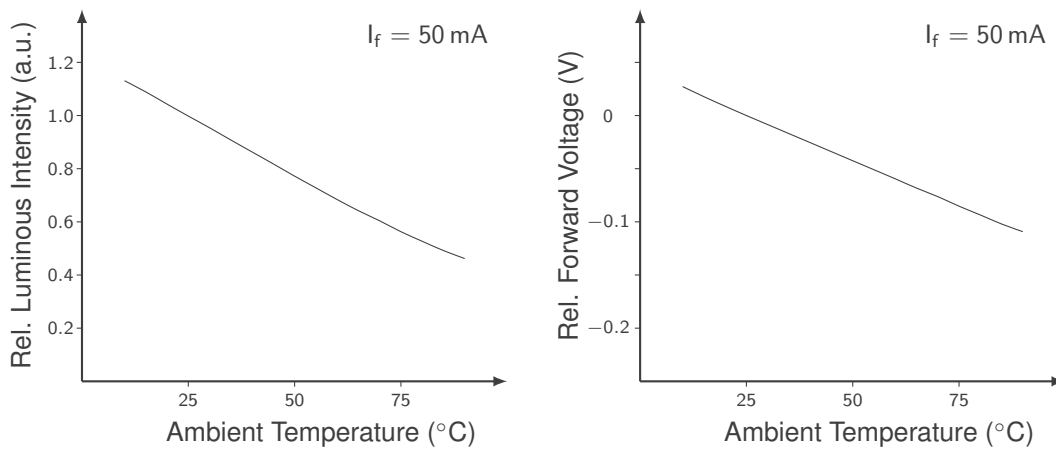
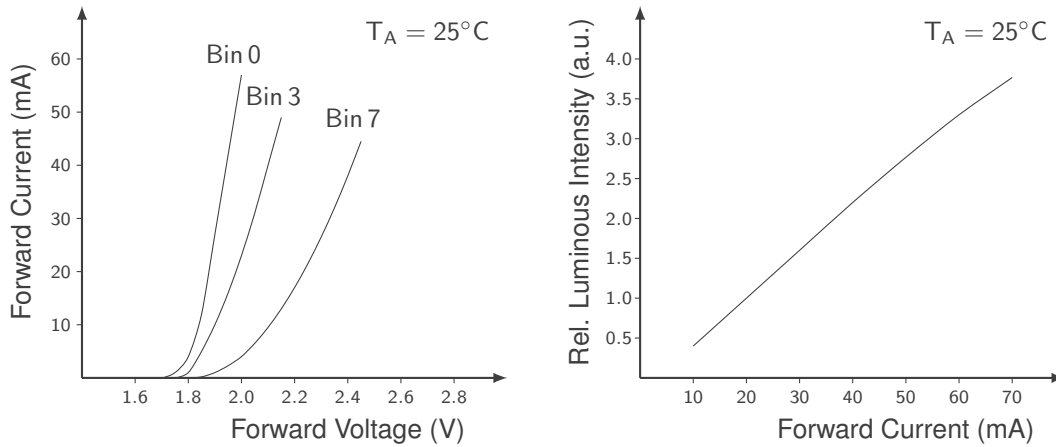

Important Usage and Application Information

Lead free product - RoHS compliant.

All products, product specifications and data to improve reliability, function, design or otherwise are subject to change without notice. The information describes the type of component and shall not be considered as assured characteristics.

Due to technical requirements components may contain dangerous substances. For information on the types in question please contact our Sales Organization.

The light output of the products may cause injuries to human eyes in circumstances where the products are viewed directly with unshielded eyes. LEDs can emit highly concentrated light which can be hazardous to the human eye. Products which incorporate these devices have to follow the safety precautions given in IEC 60825-1 and IEC 62471.

Handling and Storage Conditions

Please be careful when handling the products, particularly if an over-voltage exceeds the maximum rating. The overflow in energy may cause damage to the products. In addition these products are sensitive to static electricity. Customers have to take care when handling the products to ensure that the handling process is fully protected against static generation. Ensure that products are grounded and that the facility has conductive mats, antistatic uniforms and shoes. Antistatic containers are considered to be a good insurance against static electricity. The soldering iron point should be properly grounded. An atmospheric ionizer is recommended for use in the facility where static could be generated.

Storage ambient conditions for all LEDs in sealed packages must be within $T_A = 10...40^{\circ}\text{C}$ and relative humidity $< 60\%$. LEDs in opened packages must be used within 2 weeks after opening. Storage time under the conditions above in sealed packages must not exceed 24 months.

Packing

LEDs are packaged automatically with a quantity of 1000 or 2000 pieces into paperboard containers. Labels for identification of cathode and anode and with the lot data are placed on the box. The label shows company name and address, LED type, quantity, lot number, production date, machine number and the appropriate barcode. The box is hermetically sealed in a plastic bag for shipment.

Returns and Complaints

For complaints and returns of material a RMA-number is necessary. Samples for analysis purposes can be sent to us without credit.

Shipping Conditions

If not otherwise arranged, the "General Terms of Business of Light Avenue GmbH" apply for any shipment. If this document is not familiar to you, please request it at our nearest sales office.

Disclaimer

Attention please! Components used in life-support devices or systems must be expressly authorized for such purpose!

Critical components³ may only be used in life-support devices⁴ or systems with the express written approval by us.

Light Avenue GmbH, its affiliates, agents, and employees, and all persons acting on its or their behalf, disclaim any and all liability for any errors, inaccuracies or incompleteness contained in any datasheet or in any other disclosure relating to any product. Light Avenue makes no warranty, representation or guarantee regarding the suitability of the products for any particular purpose or the continuing production of any product. To the maximum extent permitted by applicable law, Light Avenue disclaims (i) any and all liability arising out of the application or use of any product, (ii) any and all liability, including without limitation special, consequential or incidental damages, and (iii) any and all implied warranties, including warranties of fitness for particular purpose, non-infringement and merchantability. Statements regarding the suitability of products for certain types of applications are based on Light Avenue's knowledge of typical requirements that are often placed on Light Avenue's products in generic applications. Such statements are not binding statements about the suitability of products for a particular application. It is the customer's responsibility to validate that a particular product with the properties described in the product specification is suitable for use in a particular application. Parameters provided in datasheets and/or specifications may vary in different applications and performance may vary over time. All operating parameters, including typical parameters, must be validated for each customer application by the customer's technical experts. Product specifications do not expand or otherwise modify Light Avenue's terms and conditions of business, including but not limited to the warranty expressed therein. Except as expressly indicated in writing, Light Avenue's products are not designed for use in medical, life-saving, or life-sustaining applications or for any other application in which the failure of the Light Avenue product could result in personal injury or death. Customers using or selling Light Avenue products not expressly indicated for use in such applications do so at their own risk. Please contact authorized Light Avenue personnel to obtain written terms and conditions regarding products designed for such applications. No license, express or implied, by estoppel or otherwise, to any intellectual property rights is granted by this document or by any conduct of Light Avenue. Product names and markings noted herein may be trademarks of their respective owners.

Published by:
Light Avenue GmbH
Nuernberger Strasse 13a
93152 Etterzhausen
Germany
www.light-avenue.com
info@light-avenue.com
© All Rights Reserved

¹Due to the special conditions of the manufacturing processes of lasers, the typical data or calculated correlations of technical parameters can only reflect statistical figures. These do not necessarily correspond to the actual parameters of each single product, which could differ from the typical data and calculated correlations or the typical characteristic line. If requested, e.g. because of technical improvements, these typ. data will be changed without any further notice.

²Light Measurements are done with an accuracy of $\pm 15\%$. Voltage and wavelength are measured with an accuracy of ± 0.1 V and ± 1 nm. Correlation to customer's equipment and products is required.

³A critical component is a component used in a life-support device or system whose failure can reasonably be expected to cause the failure of that life-support device or system, or to affect its safety or the effectiveness of that device or system.

⁴Life support devices or systems are intended(a) to be implanted in the human body, or(b) to support and/or maintain and sustain human life. If they fail, it is reasonable to assume that the health and the life of the user may be endangered..