

Cree® TR3547M™ LEDs

CxxxTR3547M-Sxx00

Data Sheet

Cree's TR3547M LEDs are the next generation of solid-state LED emitters that combine highly efficient InGaN materials with Cree's proprietary device technology and silicon-carbide substrates to deliver superior value for the TV-backlighting and general-illumination markets. The TR3547M LEDs are among the brightest in the top-view market while delivering a low forward voltage, resulting in a very bright and highly efficient solution. The metal backside allows for eutectic die attach and enables superior performance from improved thermal management. The design is optimally suited for industry-standard top-view packages.

FEATURES

- Rectangular LED RF Performance
 - 450 & 460 nm - 76 mW min
- High Reliability - Eutectic, Solder Paste or Preforms Attach
- Low Forward Voltage - 3.2 Vf Typical at 50 mA
- Maximum DC Forward Current – 150 mA
- 1000-V ESD Threshold Rating
- InGaN Junction on Thermally Conductive SiC Substrate
- Large LCD Backlighting
 - Television
- General Illumination
- Medium LCD Backlighting
 - Portable PCs
 - Monitors
- LED Video Displays
- White LEDs

APPLICATIONS

CxxxTR3547M-Sxx00 Chip Diagram

Top View

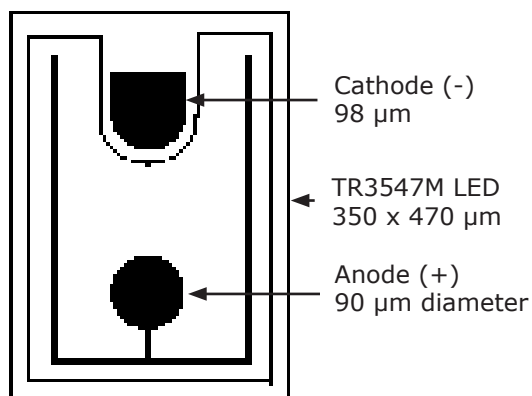

Bottom View

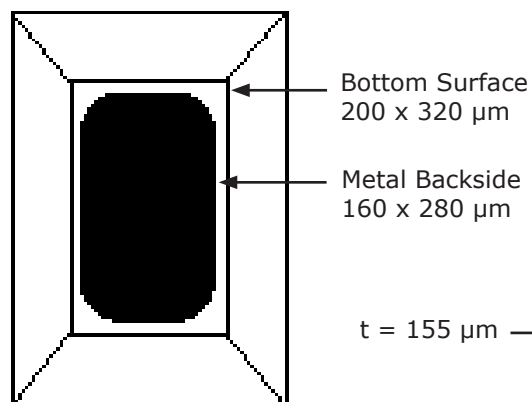

Die Cross Section

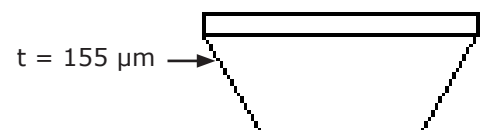

Maximum Ratings at $T_A = 25^\circ\text{C}$ <small>Notes 1&3</small>		CxxxTR3547M-Sxx00
DC Forward Current		150 mA
Peak Forward Current (1/10 duty cycle @ 1 kHz)		200 mA
LED Junction Temperature		150°C
Reverse Voltage		5 V
Operating Temperature Range		-40°C to +100°C
LED Chip Storage Temperature		-40°C to +120°C
Recommended Die Sheet Storage Conditions		$\leq 30^\circ\text{C}$ / $\leq 85\%$ RH
Electrostatic Discharge Threshold (HBM) <small>Note 2</small>		1000 V
Electrostatic Discharge Classification (MIL-STD-883E) <small>Note 2</small>		Class 2

Typical Electrical/Optical Characteristics at $T_A = 25^\circ\text{C}$, $I_f = 50\text{ mA}$ <small>Note 3</small>					
Part Number	Forward Voltage (V_f , V)			Reverse Current [$I(V_r=5V)$, μA]	Full Width Half Max (λ_D , nm)
	Min.	Typ.	Max.	Max.	Typ.
C450TR3547M-Sxx00	2.8	3.2	3.5	2	20
C460TR3547M-Sxx00	2.8	3.2	3.5	2	21

Mechanical Specifications		CxxxTR3547M-Sxx00	
Description	Dimension	Tolerance	
P-N Junction Area (μm)	310 x 430	± 35	
Chip Area (μm)	350 x 470	± 35	
Chip Thickness (μm)	155	± 15	
Au Bond Pad Diameter Anode (μm)	90	-5, +15	
Au Bond Pad Thicknesses (μm)	1.0	± 0.5	
Au Bond Pad Area Cathode (μm)	98 x 98	-5, +15	
Bottom Area (μm)	200 x 320	± 35	
Bottom Contact Metal (μm)	160 x 280	± 25	
Bottom Contact Metal Thickness (μm)	3.0	± 1.0	

Notes:

- Maximum ratings are package-dependent. The above ratings were determined using a Cree SMT package (with silicone encapsulation and intrinsic AuSn metal die attach) for characterization. Ratings for other packages may differ. Junction temperature should be characterized in a specific package to determine limitations. Assembly processing temperature must not exceed 325°C (< 5 seconds).
- Product resistance to electrostatic discharge (ESD) according to the HBM is measured by simulating ESD using a rapid avalanche energy test (RAET). The RAET procedures are designed to approximate the maximum ESD ratings shown.
- All products conform to the listed minimum and maximum specifications for electrical and optical characteristics when assembled and operated at 50 mA within the maximum ratings shown above. Efficiency decreases at higher currents. Typical values given are within the range of average values expected by manufacturer in large quantities and are provided for information only. All measurements were made using lamps in T-1 3/4 packages (with Hysol OS4000 epoxy encapsulant and intrinsic AuSn metal die attach). Optical characteristics measured in an integrating sphere using Illuminance E.

Standard Bins for CxxxTR3547M-Sxx00

LED chips are sorted to the **radiant flux** and **dominant wavelength** bins shown. A sorted die sheet contains die from only one bin. Sorted die kit (CxxxTR3547M-Sxxxx) orders may be filled with any or all bins (CxxxTR3547M-xxxx) contained in the kit. All radiant flux and dominant wavelength values shown and specified are at $I_f = 50 \text{ mA}$.

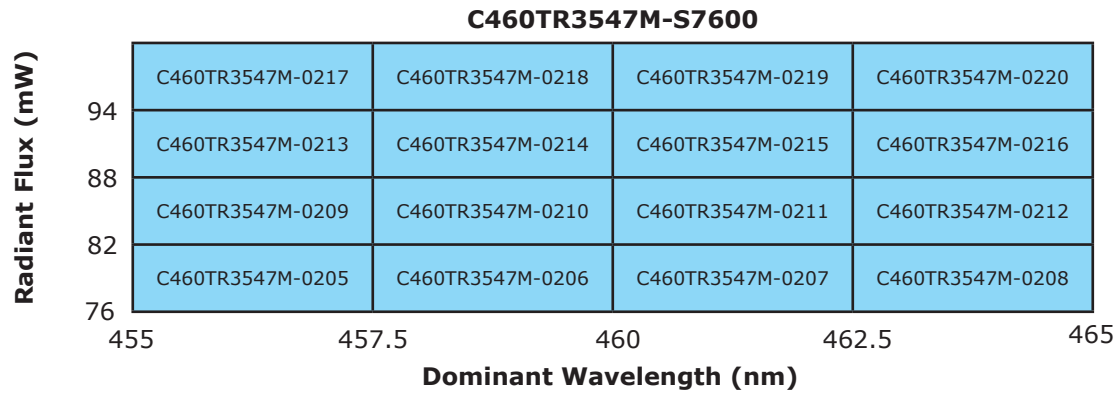
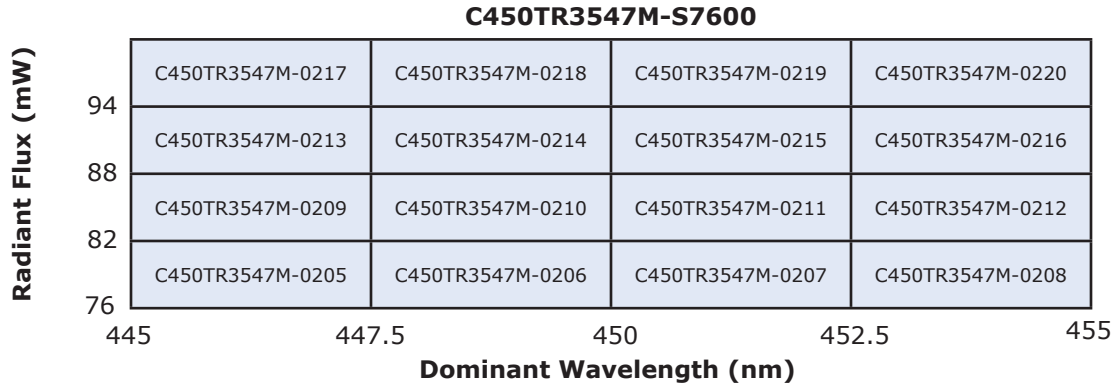

Characteristic Curves

These are representative measurements for the TR LED product. Actual curves will vary slightly for the various radiant flux and dominant wavelength bins.

Forward Current vs. Forward Voltage

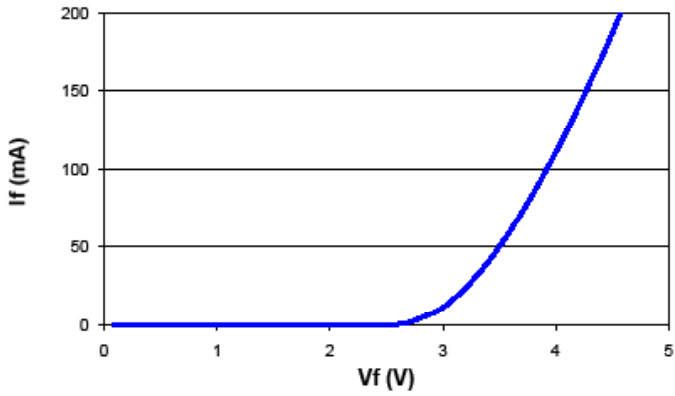

Wavelength Shift vs. Forward Current

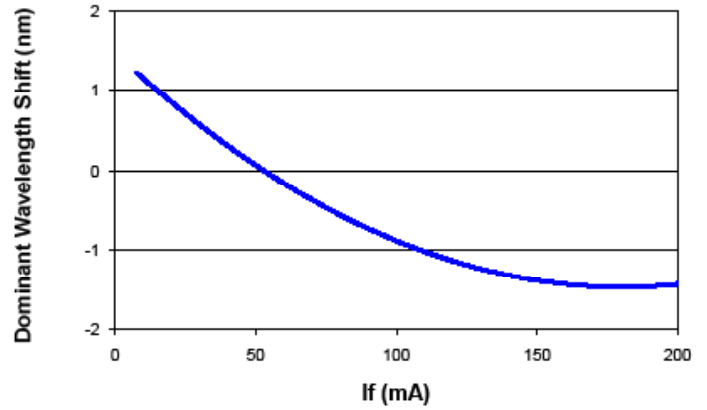

Relative Intensity vs. Forward Current

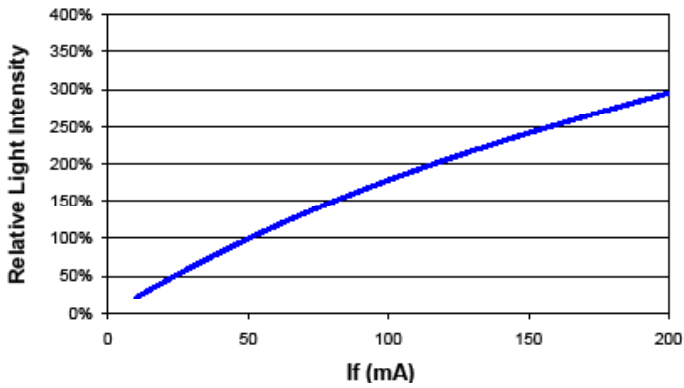

Relative Intensity vs Peak Wavelength

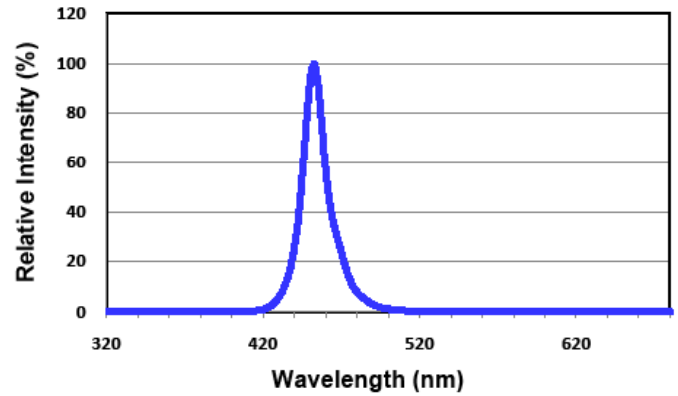

Radiation Pattern

This is a representative radiation pattern for the TR LED product. Actual patterns will vary slightly for each chip.

