

Cree® TR3050™ LEDs

CxxxTR3050-Sxx00

Data Sheet - 20mA-rated

Cree's TR™ LEDs are the newest generation of solid-state LED emitters that combine highly efficient InGaN materials with Cree's proprietary device technology and silicon carbide substrates to deliver superior value for the LCD sideview market. The TR LEDs are among the brightest in the sideview market while delivering a low forward voltage resulting in a very bright and highly efficient solution for the 0.6-mm and 0.8-mm sideview market. The design is optimally suited for industry standard sideview packages as it is die attachable with clear epoxy and has two top contacts, consistent with industry standard packaging.

FEATURES

- Rectangular LED Rf Performance
 - 450 & 460 nm
 - ◆ TR-3050™ – 36 mW min.
- Epoxy Die Attach
- Low Forward Voltage - 2.95 V Typical at 20 mA
- 1000-V ESD Threshold Rating
- InGaN Junction on Thermally Conductive SiC Substrate

APPLICATIONS

- Small LCD Backlighting – 0.8 mm & 0.6 mm sideview packages
 - Mobile Appliances
 - Digital Cameras
 - Car Navigation Systems
- Medium LCD Backlighting – 0.8 mm & 0.6 mm sideview packages
 - Portable PCs
 - Monitors
- LED Video Displays
- General Illumination

CxxxTR3050-Sxx00 Chip Diagram

Top View

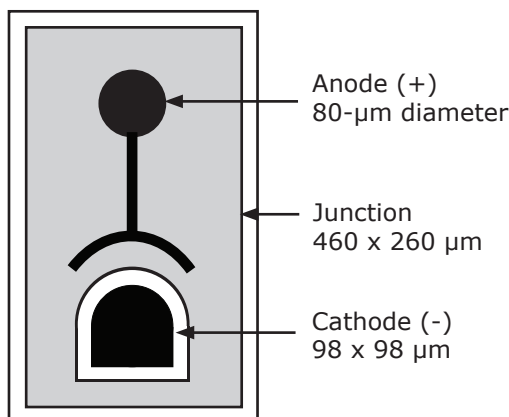

Die Cross Section



Bottom View

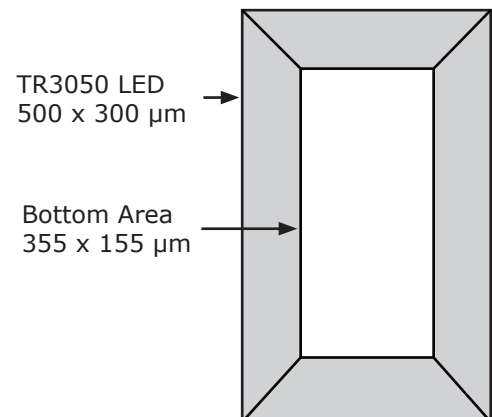

Maximum Ratings at $T_A = 25^\circ\text{C}$ <small>Notes 1&3</small>		CxxxTR3050-Sxx00
DC Forward Current		70 mA
Peak Forward Current (1/10 duty cycle @ 1 kHz)		100 mA
LED Junction Temperature		125°C
Reverse Voltage		5 V
Operating Temperature Range		-40°C to +100°C
LED Chip Storage Temperature		-40°C to +120°C
Recommended Die Sheet Storage Conditions		$\leq 30^\circ\text{C}$ / $\leq 85\%$ RH
Electrostatic Discharge Threshold (HBM) <small>Note 2</small>		1000 V
Electrostatic Discharge Classification (MIL-STD-883E) <small>Note 2</small>		Class 2

Typical Electrical/Optical Characteristics at $T_A = 25^\circ\text{C}$, $I_f = 20\text{ mA}$ <small>Note 3</small>					
Part Number	Forward Voltage (V_f , V)			Reverse Current [$I(V_r=5\text{V})$, μA]	Full Width Half Max (λ_D , nm)
	Min.	Typ.	Max.	Max.	Typ.
C450TR3050-Sxx00	2.7	2.95	3.4	2	20
C460TR3050-Sxx00	2.7	2.95	3.4	2	21

Mechanical Specifications		CxxxTR3050-Sxx00	
Description	Dimension	Tolerance	
P-N Junction Area (μm)	260 x 460	± 35	
Chip Area (μm)	300 x 500	± 35	
Chip Thickness (μm)	140	± 15	
Au Bond Pad Diameter Anode (μm)	80	-5, +15	
Au Bond Pad Thicknesses (μm)	1.0	± 0.5	
Au Bond Pad Area Cathode (μm)	98 x 98	-5, +15	
Bottom Area (μm)	155 x 355	± 35	

Notes:

1. Maximum ratings are package dependent. The above ratings were determined using a T-1 3/4 package (with Hysol OS4000 epoxy encapsulation and clear epoxy die attach) for characterization. Ratings for other packages may differ. The forward currents (DC and Peak) are not limited by the die but by the effect of the LED junction temperature on the package. The junction temperature limit of 125°C is a limit of the T-1 3/4 package; junction temperature should be characterized in a specific package to determine limitations. Assembly processing temperature must not exceed 325°C (< 5 seconds).
2. Product resistance to electrostatic discharge (ESD) according to the HBM is measured by simulating ESD using a rapid avalanche energy test (RAET). The RAET procedures are designed to approximate the maximum ESD ratings shown.
3. All products conform to the listed minimum and maximum specifications for electrical and optical characteristics when assembled and operated at 20 mA within the maximum ratings shown above. Efficiency decreases at higher currents. Typical values given are within the range of average values expected by manufacturer in large quantities and are provided for information only. All measurements were made using lamps in T-1 3/4 packages (with Hysol OS4000 epoxy encapsulant and clear epoxy die attach). Optical characteristics measured in an integrating sphere using Illuminance E.

Standard Bins for CxxxTR3050-Sxx00

LED chips are sorted to the **radiant flux** and **dominant wavelength** bins shown. A sorted die sheet contains die from only one bin. Sorted die kit (CxxxTR3050-Sxxxx) orders may be filled with any or all bins (CxxxTR3050-xxxx) contained in the kit. All radiant flux and dominant wavelength values shown and specified are at $I_f = 20$ mA.

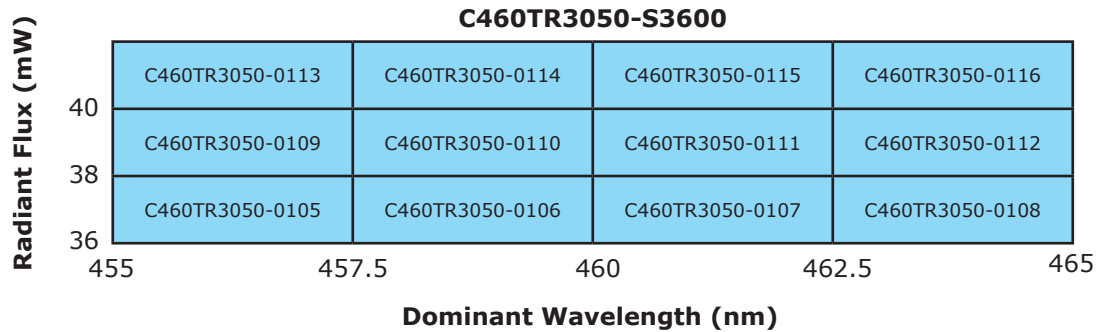
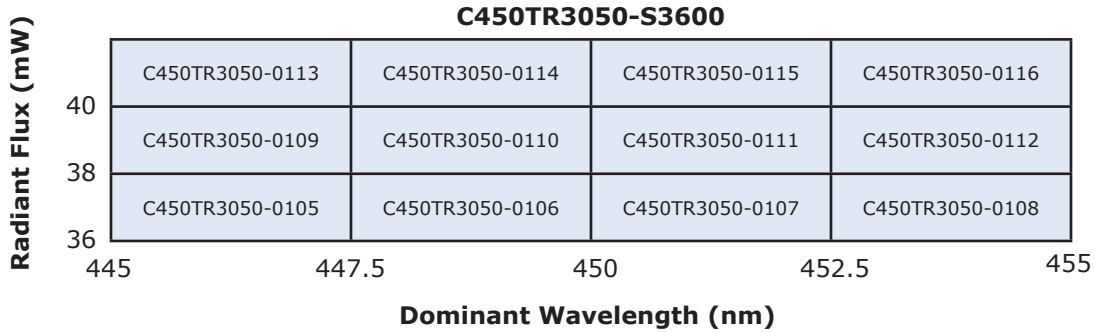

Characteristic Curves

These are representative measurements for the TR LED product. Actual curves will vary slightly for the various radiant flux and dominant wavelength bins.

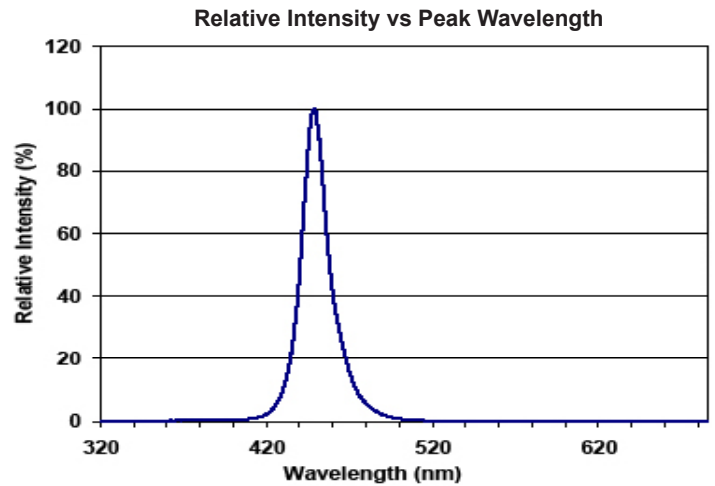
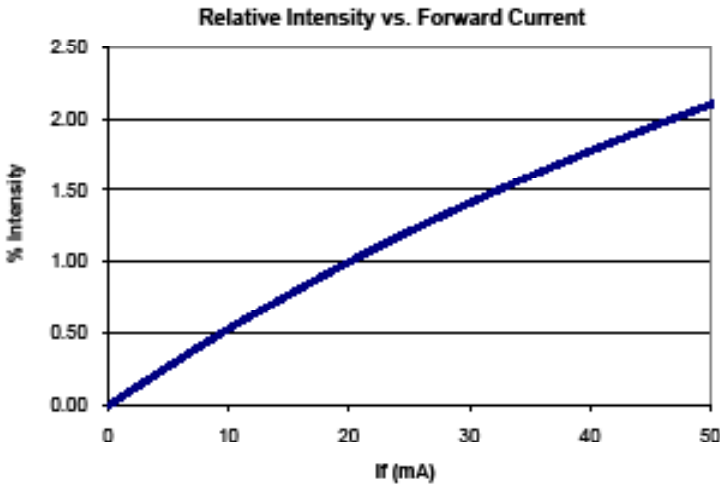
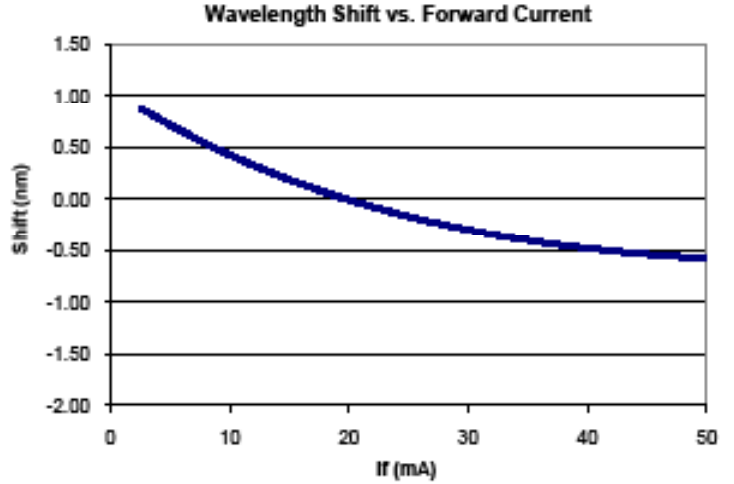
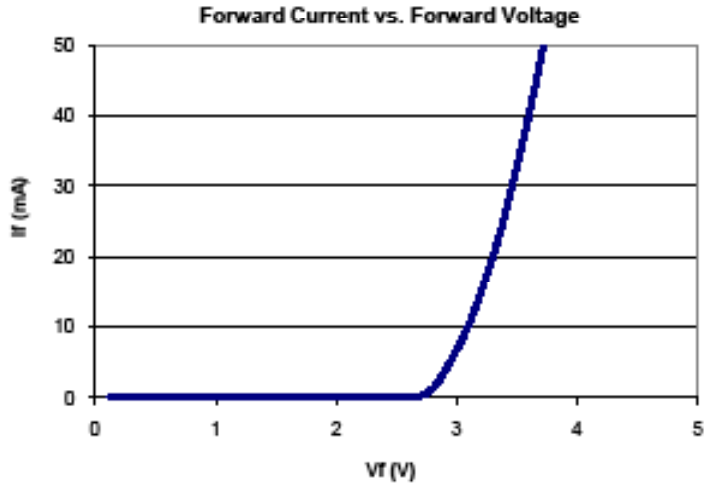

Radiation Pattern

This is a representative radiation pattern for the TR LED product. Actual patterns will vary slightly for each chip.

