

# Cree® UltraThin® Gen 1 LEDs

## Data Sheet

### CxxxUT190-Sxxxx

Cree's UltraThin LEDs combine highly efficient InGaN materials with Cree's proprietary G•SiC® substrate to deliver superior price/performance for blue LEDs. These vertically structured LED chips are small in size and require a low forward voltage. Cree's UT™ series chips are tested for conformity to optical and electrical specifications, including 2000 V ESD. These UT190™ LEDs are ideal for a wide range of indicator and display applications where a small footprint and/or a thin form factor are required.

#### FEATURES

- Small Chip – 190 x 190 x 85  $\mu\text{m}$
- RF Performance @ 20 mA
  - 450 nm – 10+ mW
  - 460 nm – 8+ mW
  - 470 nm – 8+ mW
- Low Forward Voltage (Vf)
  - 2.9 V Typical at 5 mA
- Single Wire Bond Structure
- 2kV Class 2 ESD Rating

#### APPLICATIONS

- Mobile Phone Keypad Backlights
- Audio Product Display Lighting
- Indicators
  - Automotive
  - Consumer Products
  - Wearable Devices
  - White Goods

#### CxxxUT190-Sxxxx Chip Diagram

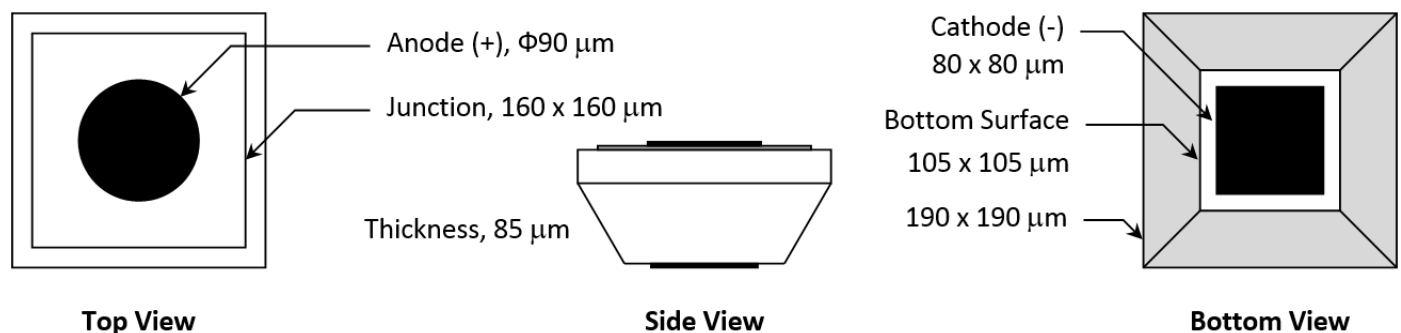

Maximum Ratings at $T_A = 25^\circ\text{C}$ <small>Notes 1&amp;3</small>		CxxxUT190-Sxxxx
DC Forward Current		30 mA
Peak Forward Current (1/10 duty cycle @ 1 kHz)		100 mA
LED Junction Temperature		125°C
Reverse Voltage		5 V
Operating Temperature Range		-40°C to +100°C
LED Chip Storage Temperature		-40°C to +120°C
Recommended Die Sheet Storage Conditions		$\leq 30^\circ\text{C}$ / $\leq 85\%$ RH
Electrostatic Discharge Threshold (HBM) <small>Note 2</small>		2000 V
Electrostatic Discharge Classification (MIL-STD-883E) <small>Note 2</small>		Class 2

Typical Electrical/Optical Characteristics at $T_A = 25^\circ\text{C}$ , $I_f = 5\text{ mA}$ <small>Note 3</small>					
Part Number	Forward Voltage ( $V_f$ , V)			Reverse Current [ $I(V_r=5\text{ V})$ , $\mu\text{A}$ ]	Full Width Half Max ( $\lambda_D$ , nm)
	Min.	Typ.	Max.	Max.	Typ.
C450UT190-Sxxxx	2.7	2.9	3.1	2	21
C460UT190-Sxxxx	2.7	2.9	3.1	2	21
C470UT190-Sxxxx	2.7	2.9	3.1	2	22

Mechanical Specifications		CxxxUT190-Sxxxx	
Description	Dimension	Tolerance	
P-N Junction Area ( $\mu\text{m}$ )	160 x 160	$\pm 25$	
Chip Top Area ( $\mu\text{m}$ )	190 x 190	$\pm 25$	
Chip Bottom Area ( $\mu\text{m}$ )	105 x 105	$\pm 25$	
Chip Thickness ( $\mu\text{m}$ )	85	$\pm 10$	
Au Bond Pad Diameter ( $\mu\text{m}$ )	90	-5, +15	
Au Bond Pad Thickness ( $\mu\text{m}$ )	1.2	$\pm 0.5$	
Backside Contact Metal Area ( $\mu\text{m}$ )	80 x 80	$\pm 25$	

### Notes:

- Maximum ratings are package dependent. The above ratings were determined using a thru-hole package (with Hysol® OS4000 encapsulant) for characterization. Ratings for other packages may differ. The forward currents (DC and Peak) are not limited by the die but by the effect of the LED junction temperature on the package. The junction temperature limit of 125°C is a limit of the thru-hole package; junction temperature should be characterized in a specific package to determine limitations. Assembly processing temperature must not exceed 325°C (< 5 seconds).
- Product resistance to electrostatic discharge (ESD) according to the HBM is measured by simulating ESD using a rapid avalanche energy test (RAET). The RAET procedures are designed to approximate the minimum ESD ratings shown. The ESD classification of Class 2 is based on sample testing according to MIL-STD-883E.
- All products conform to the listed minimum and maximum specifications for electrical and optical characteristics when assembled and operated at 5 mA within the maximum ratings shown above. Efficiency decreases at higher currents. Typical values given are within the range of average values expected by manufacturer in large quantities and are provided for information only. All measurements were made using lamps in thru-hole packages (with Hysol OS4000 encapsulant). The amount of die attach adhesive used will affect light output; it is recommended that the adhesive amount be optimized to meet the requirements of each specific application. Optical characteristics measured in an integrating sphere using Illuminance E.
- Specifications are subject to change without notice.

## Standard Bins for CxxxUT190-Sxxxx

LED chips are sorted to the **radiant flux** and **dominant wavelength** bins shown. Sorted die sheets contain die from only one bin. A sorted die kit (CxxxUT190-Sxxxx) may be filled with any or all bins (CxxxUT190-xxxx) contained in the kit. All radiant flux values are measured at  $I_f = 20$  mA and all dominant wavelength values are measured at  $I_f = 5$  mA.

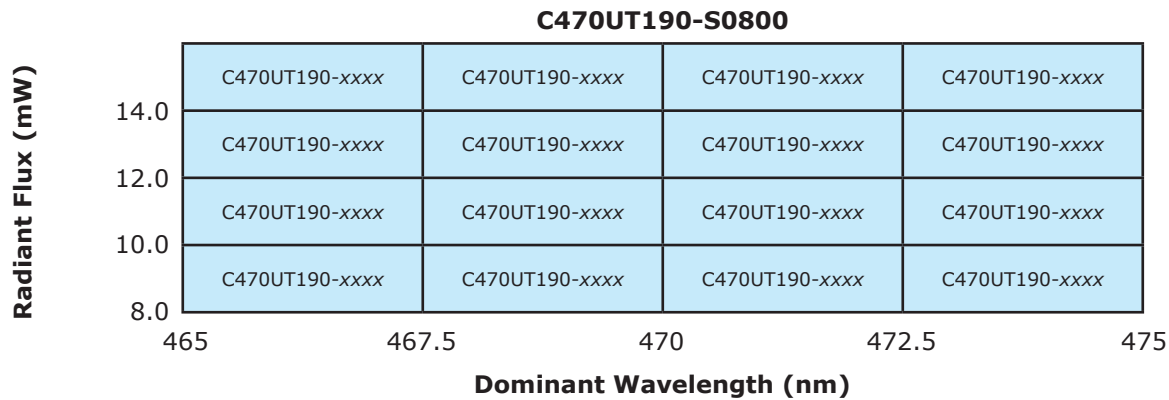
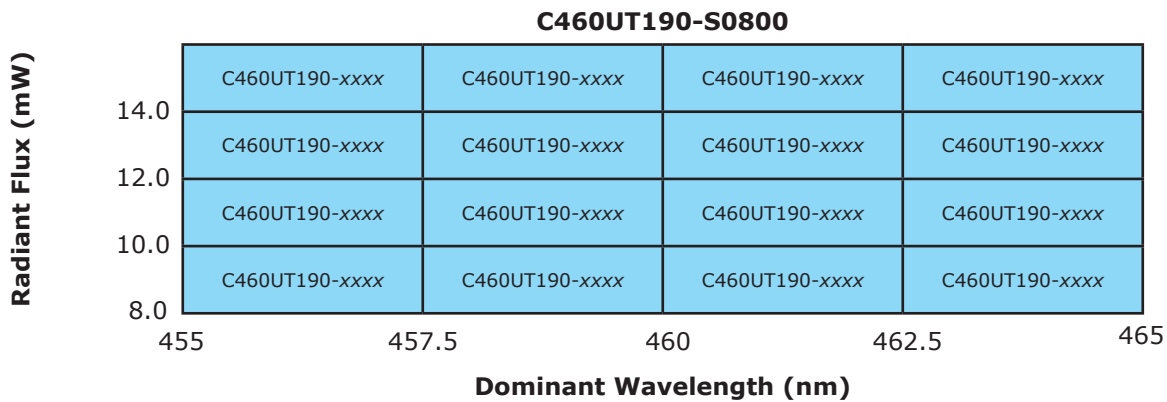
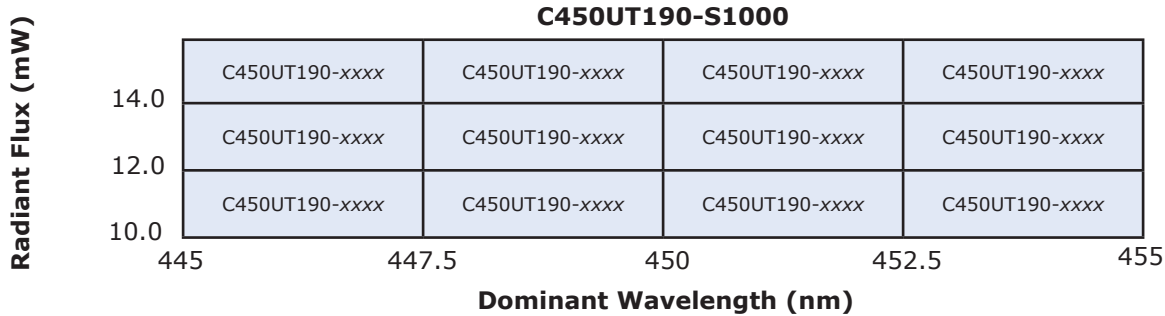

## Characteristic Curves

These are representative measurements for the UT190 product. Actual curves will vary slightly for the various radiant flux and dominant wavelength bins.

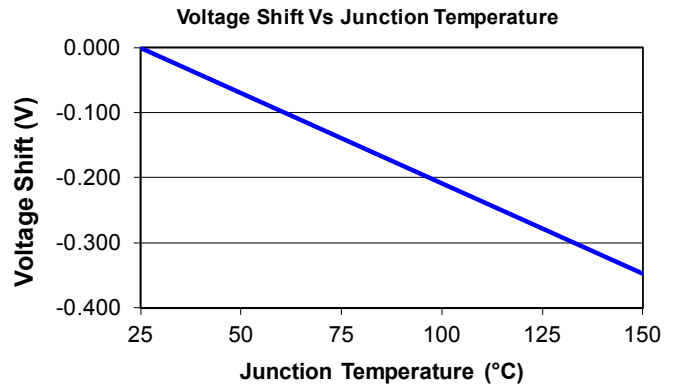
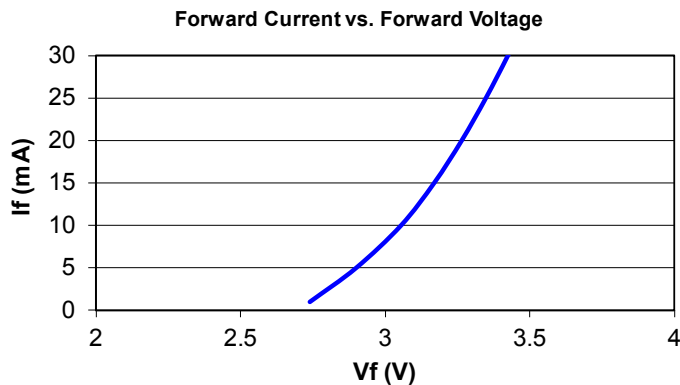
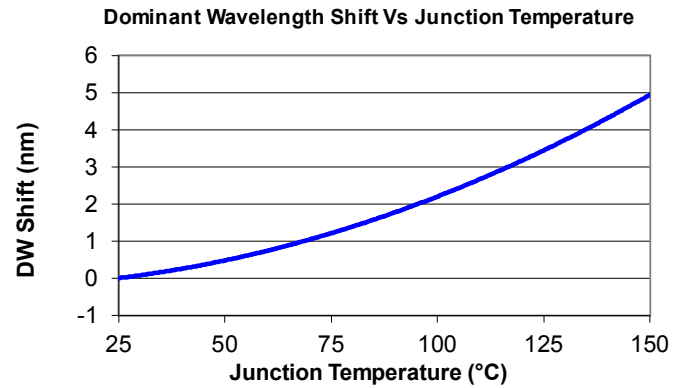
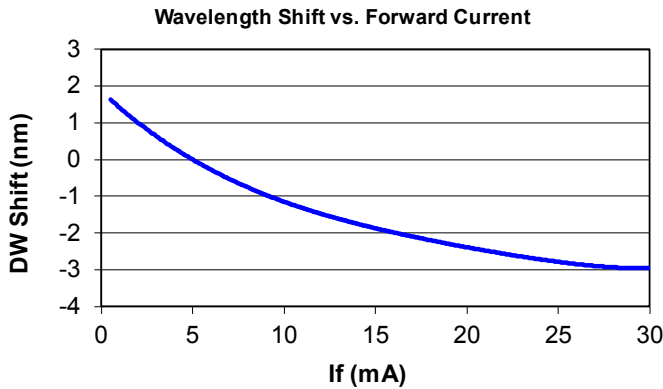
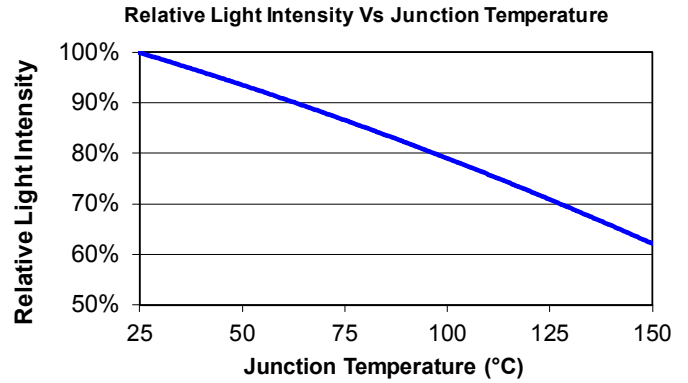
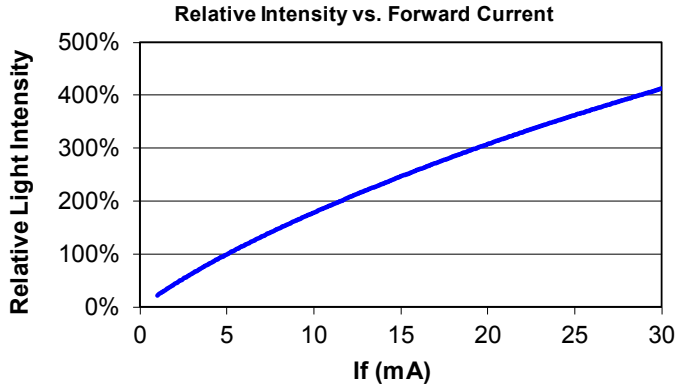

## Radiation Pattern

This is a representative radiation pattern for the UltraThin Chip LED product. Actual patterns will vary slightly for each chip.

