

C4L-OM5090TGG

High Power Oval LED True Green (530 nm)

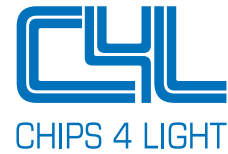

Chips 4 Light 50/90 Oval LED series is designed for high intensity and high temperature applications. Due to the unique production method the maximum of the light emission is nearly homogeneous across the complete viewing angle. The usage of special thermoplastic materials allows junctions temperatures up to 150° C. A highly automated production process ensures high volume capability and competitive pricing.

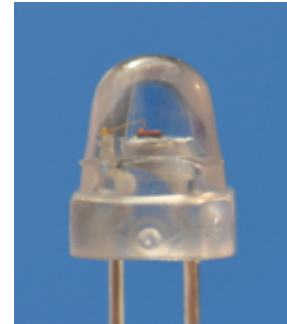

Features

- Long lifetime
- High optical precision
- Sturdy design
- High optical efficiency
- High operating temperatures
- Ultra-high-brightness performance
- Spatial radiation angle 50/90 degree

Applications

- Solid state lighting
- Architectural lighting
- Marker lights
- Industrial applications
- Ultra high brightness indicator
- Illuminator
- Traffic signals

Ordering information

TYPE	DOMINANT WAVELENGTH	LUMINOUS FLUX
C4L-OM5090TGG-06FQ09	515 ... 550 nm	3,6 ... 14 lm

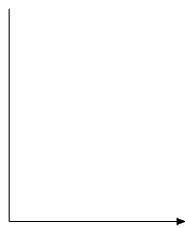

C 4 L Chips 4 Light
O Oval LED
M Medium current
5 0 9 0 5090° vertical and horizontal viewing angle
T G True green
G InGaN high efficiency chip
0 Dominant wavelength min.: 515 nm
6 Dominant wavelength max.: 550 nm
F Luminous flux min.: 3,6 lm
Q Luminous flux max.: 14 lm
0 Voltage min.: 2,75 V
9 Voltage max.: 3,85 V

Customers' special wishes are also welcome.

C4L-OM5090TGG

High Power Oval LED True Green (530 nm)



Electro-optical characteristics ($T_A = 25^\circ\text{C}$)¹

PARAMETER	SYMBOL	CONDITION	MIN.	TYP. ²	MAX.	UNIT
Forward voltage	V_F	$I_F = 50\text{ mA}$	2,75	3,2	3,85	V
Dominant wavelength	λ_{dom}	$I_F = 50\text{ mA}$	515		550	nm
Luminous flux ³	Φ_v	$I_F = 50\text{ mA}$	3,6		14	lm
Luminous intensity	I_v	$I_F = 50\text{ mA}$		4		cd
Spectral bandwidth	$\Delta\lambda$	$I_F = 50\text{ mA}$		30		nm
Viewing angle	$2\Theta_{1/2}$			5090		°

Maximum ratings ($T_A = 25^\circ\text{C}$)⁴

PARAMETER	SYMBOL	MINIMUM	MAXIMUM	UNIT
Operating temperature range	T_{op}	-40	120	°C
Storage temperature range	T_{stg}	-50	125	°C
Forward current	I_F		50	mA
LED junction temperature	T_j		150	°C
Reverse voltage	V_R		10	V
Power dissipation	P_D		180	mW

Binning ($I_F = 50\text{ mA}$)

DOMINANT WAVELENGTH (NM)			LUMINOUS FLUX (LM)			VOLTAGE (V)		
Bin	Min.	Max.	Bin	Min.	Max.	Bin	Min.	Max.
0	515	520	F	3,6	4	0	2,75	2,95
1	520	525	G	4	4,5	1	2,85	3,05
2	525	530	H	4,5	5	2	2,95	3,15
3	530	535	I	5	5,6	3	3,05	3,25
4	535	540	J	5,6	6,4	4	3,15	3,35
5	540	545	K	6,4	7,2	5	3,25	3,45
6	545	550	L	7,2	8	6	3,35	3,55
			M	8	9	7	3,45	3,65
			N	9	10	8	3,55	3,75
			O	10	11,25	9	3,65	3,85
			P	11,25	12,5			
			Q	12,5	14			

C4L-OM5090TGG

High Power Oval LED True Green (530 nm)



Thermal characteristics

PARAMETER	SYMBOL	VALUE	UNIT
Thermal resistance	$R_{\Theta J-Pin}$	85	K/W
Soldering temperature (3 seconds maximum)	T_{solder}	260	°C

Outline

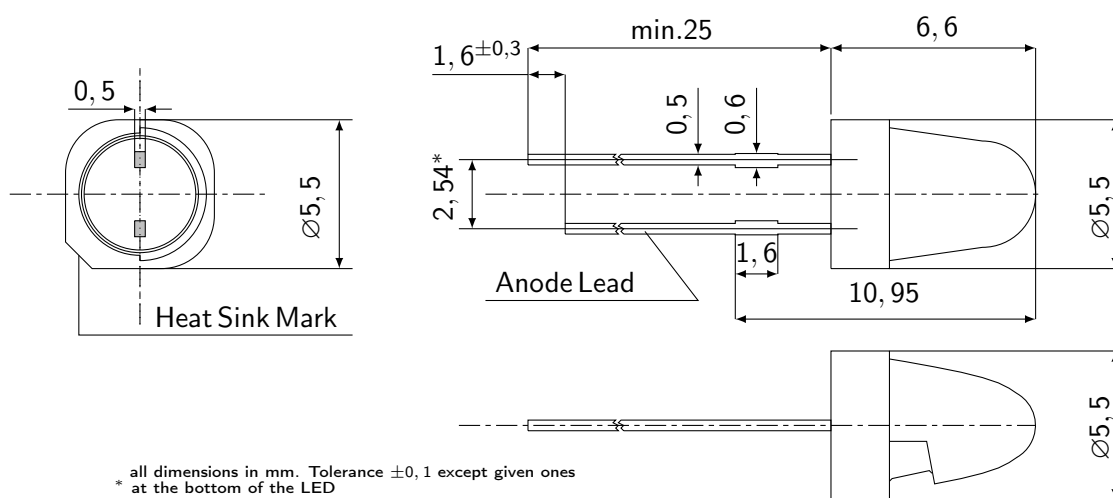

Recommended Solderpad

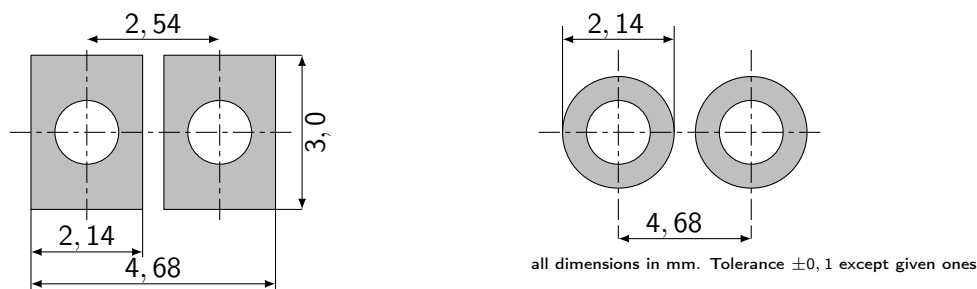

Packaging and Labelling

LEDs are packaged automatically with a quantity of 1000 or 2000 pieces into paperboard containers. Labels for identification of cathode and anode and with the lot data are placed on the box. The label shows company name and address, LED type, quantity, lot number, production date, machine number and the appropriate barcode. The box is hermetically sealed in a plastic bag for shipment.

Soldering

METHOD	SOLDERING CONDITIONS	REMARK (VALID FOR TTW AND LEAD FREE SOLDERING)
TTW soldering	Bath temperature 250°C, Immersion time: within 5 sec.	Soldering system: Very good soldering results have been achieved on ERSA soldering systems at a bath temperature of 250°C and at a feeding rate of 1.2 m/s.
Lead free soldering	Bath temperature 260°C, immersion time: within 3 sec.	We recommend dosage of the soldering flux with a spray fluxer or nozzle fluxer. If this is not possible, one should pay attention to avoid contact of the soldering flux and the LED body and to keep the recommended pre-heat period. We recommend to use a water based soldering flux (e.g. Pacific 2007 interflux Electronics NV). Do not use alcohol based fluxer.
Soldering iron	30W or smaller, temperature at tip of iron maximum 300°C, soldering time within 3 sec.	During soldering take care not to press the tip of iron against the lead. To prevent heat from being transferred directly to the lead hold the lead with a pair of tweezers while soldering.

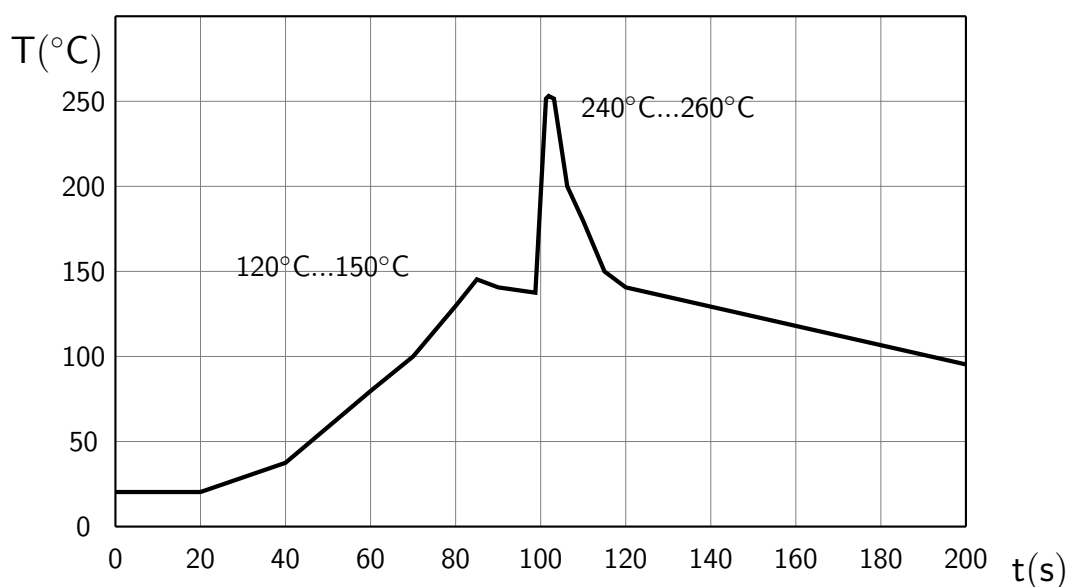

Actual solder profile may vary from the example given, and is very much depending on wave type, machine configuration, geometrical configuration, board shape etc. It is strongly recommended to optimize and evaluate the actual soldering conditions carefully for each individual project before releasing the soldering process.

Device polarity

The LED chip is mounted on the anode leg. The heat sink mark indicates also the anode.

Mounting

- The lead should be bent at a point located at least 0.8 mm away from the package. Bending should be performed with base firmly fixed by means of a jig or radio pliers.
- Lead binding should be carried out prior to soldering and never during or after soldering.
- Locate the lead, ensuring correct alignment, thereby reducing stress to the LED.
- Due to thermoplastic encapsulant the LEDs are slightly more sensitive to the effects of stress during automatic mounting (such as mechanical stress within the package resin transmitted via the leads).
- The insertion pressure and clinching angle must both be minimized so as to minimize the lead-cutting stress and clinch stress applied to the LED lamps.
- Please evaluate the specific mounting process carefully for each individual project before actually using the automatic mounting machine to mount these LED lamps. Setting the best clinch angle and force may require experimentation when the automatic insertion machine is first set up.
- Please pay attention: The heat sink lead is also the anode lead at the same time. Metal pads on PCB surrounding the heat sink leads of the LEDs should be as large as possible.

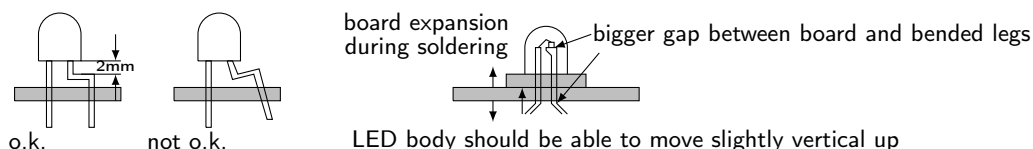

Cleaning

- Do not use untested chemical liquids, because they may cause crack formation or haze on the surface of the plastic body.
- When cleaning is required, refer to the following table for the proper chemical to be used (Immersion time less than 3 minutes at room temperature).

SOLVENT	ADABTABILITY
Water	can be used
Amonium Hydroxide	can be used

C4L-OM5090TGG

High Power Oval LED True Green (530 nm)



Typical electro-optical data²

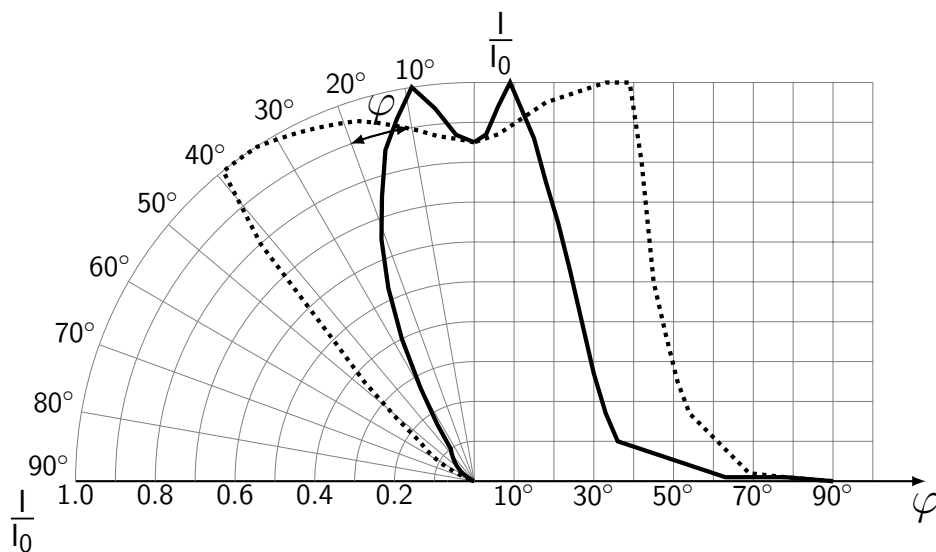
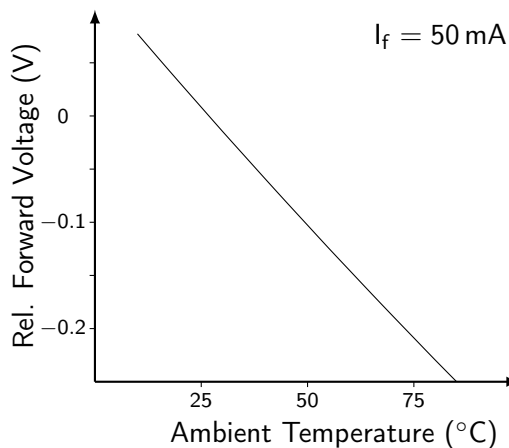
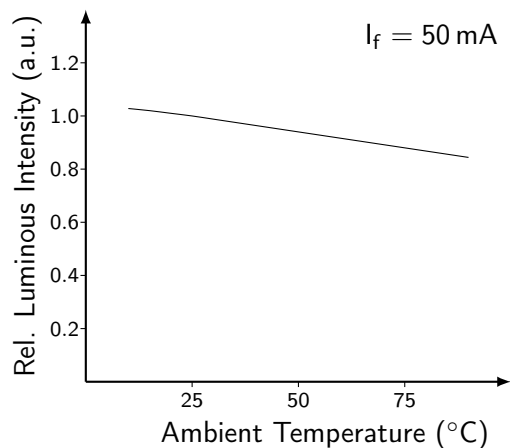
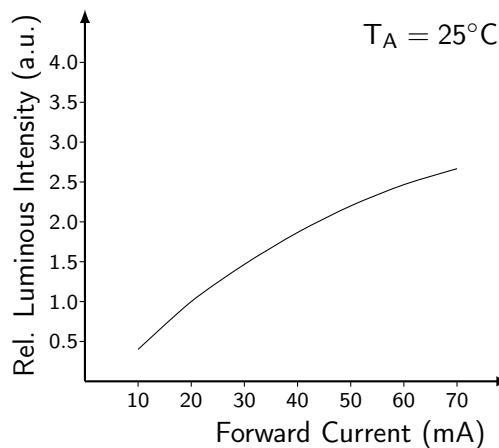
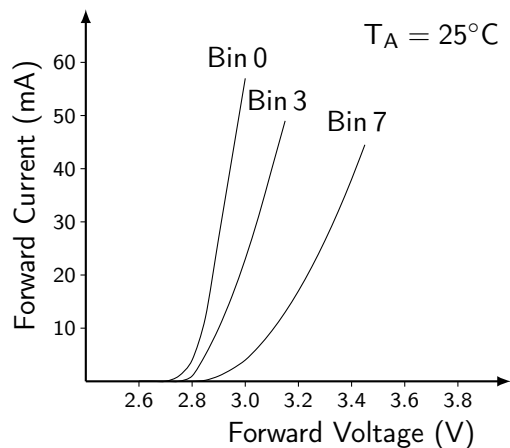

C4L-OM5090TGG

High Power Oval LED True Green (530 nm)



Notes:

- The usage of LEDs in life-support devices or systems has to be authorized by the supplier expressly in writing!
- The light output of the products may cause injuries to human eyes in circumstances where the products are viewed directly with unshielded eyes. In case of infrared light emitting products and depending on the mode of operation, infrared devices emit highly concentrated non visible infrared light which can be hazardous to the human eye. Products which incorporate these devices have to follow the safety precautions given in IEC 60825-1 and IEC 62471.
- Lead free product - RoHS compliant.
- Should you intend to provide the LEDs with a conformal coating, please take care to use a water-based coating.
- Please be careful when handling the products, particularly if an over-voltage exceeds the maximum rating. The overflow in energy may cause damage to the products. In addition these products are sensitive to static electricity. Customers have to take care when handling the products to ensure that the handling process is fully protected against static generation. Ensure that products are grounded and that the facility has conductive mats, antistatic uniforms and shoes. Antistatic containers are considered to be a good insurance against static electricity. The soldering iron point should be properly grounded. An atmospheric ionizer is recommended for use in the facility where static could be generated.
- Storage ambient conditions for all LEDs in sealed packages must be within $T_A = 10...40^{\circ}\text{C}$ and relative humidity $<60\%$. LEDs in opened packages must be used within 2 weeks after opening. Storage time under the conditions above in sealed packages must not exceed 24 months.
- The information in this document is subject to change without notice and describes the product generally. It shall not be considered as assured characteristics or detailed specification.

Published by:

Chips 4 Light GmbH

Nuernberger Strasse 13a, 93152 Etterzhausen, Germany

www.chips4light.com

info@chips4light.com

© All Rights Reserved

¹After 1 minute of operation, $R_{thja} = 180^{\circ}\text{C}/\text{W}$

²Typical (Typ) data are defined as long-term production mean values. These values are not specified and only given for information.

³Measurements are done with an accuracy of $\pm 15\%$. Correlation to customer's equipment and products is required.

⁴Not to be exceeded at any time.